



positioning
patients for life.®



VacQfix™ Cushions

VacQfix™ Cushions

VacQfix™ Cushions offer dependability and reproducibility for today's sophisticated treatment methods.

VacQfix™ cushions are custom formed for patient comfort and positioning reproducibility, becoming rigid when a vacuum is applied. They can be easily cleaned and reused after each course of treatment. Fine denier fabric and small diameter foam-bead fill combine to increase conformity and reproducibility.

Quality

VacQfix™ Cushions are designed to be robust and maintain their form throughout the course of treatment.

Optional VacQfix™ Indexer

An optional VacQfix™ Indexer can be used for increased reproducibility of the VacQfix™ cushion to the couch top.

SingleStep™ Valve

Unlike other systems, the unique SingleStep™ Valve does not require a secondary cap to ensure leak-free operation.

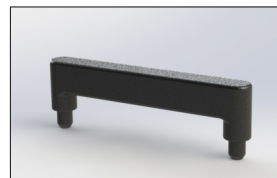

Prone VacQfix Indexer



SingleStep™ Valve



Economy
2-Piece Valve
Available upon request.



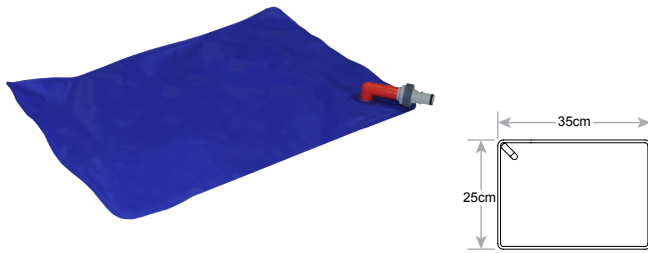

RT-4517-2535F2.0 VacQfix Cushion, Nylon, 25 cm x 35 cm, 2.0-liter fill

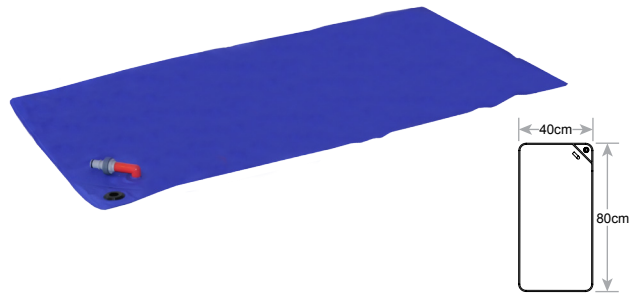

RT-4517-4080F15 VacQfix Cushion, 40 cm x 80 cm, Nylon, 15-liter fill, for extremities

*RT-4517-4079VF15 - VacQfix Cushion, Thigh Compression SBRT, 40 cm x 80 cm, Nylon, 15-liter fill is also available with the same dimensions as RT-4517-4080F15

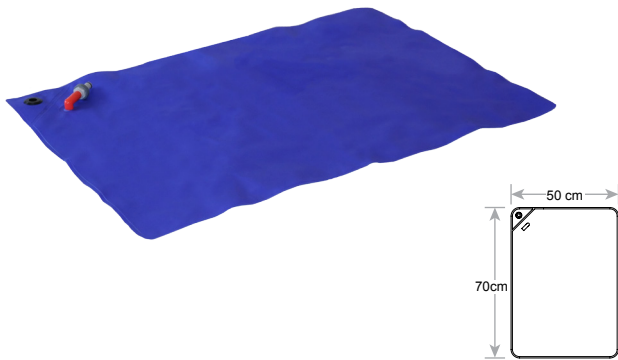

RT-4517-5070F15 VacQfix Cushion, 50 cm x 70 cm, Nylon, 15-liter fill, for extremities

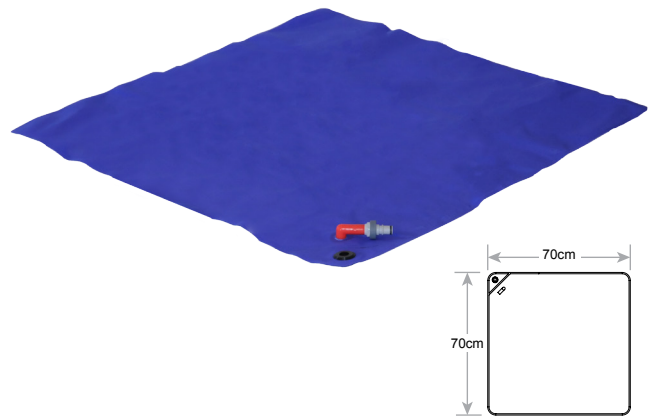

RT-4517-7070F20 VacQfix Cushion, 70 cm x 70 cm, Nylon, 20-liter fill, for upper body

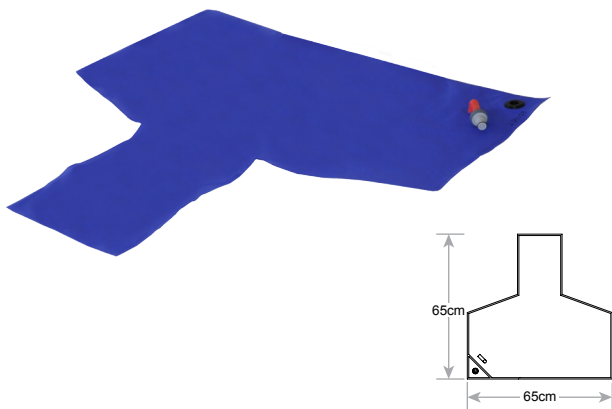

RT-4517-T6565F7 VacQfix Cushion, 65 cm x 65 cm, Nylon, T-Shaped, 7-liter fill, for head & shoulders

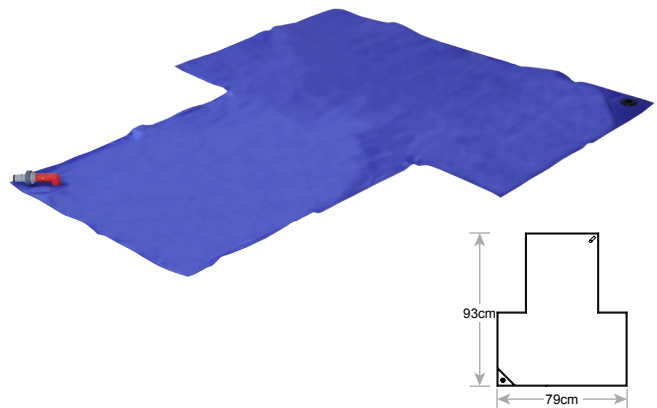

RT-4517-T7993F20 VacQfix Cushion, Breast Board Cushion, 79 cm x 93 cm, Nylon, 20-liter fill, with SingleStep Valve

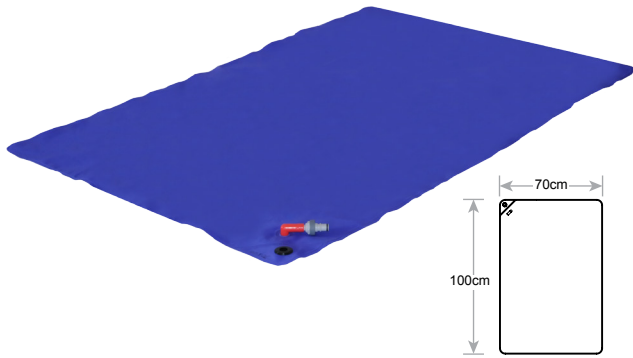

RT-4517-10070F35 VacQfix Cushion, 100 cm x 70 cm, Nylon, 35-liter fill

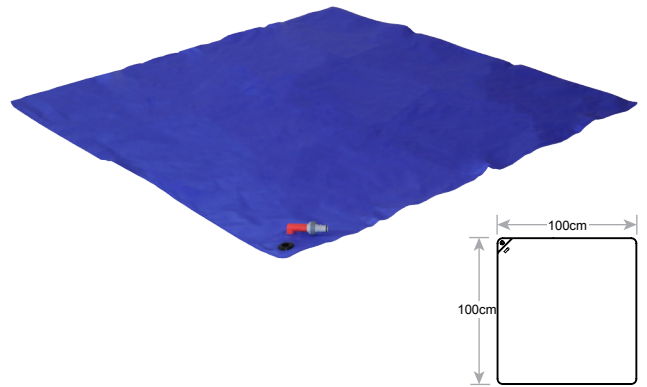

RT-4517-100100F40 VacQfix Cushion, 100 cm x 100 cm, Nylon, 40-liter fill, for upper body

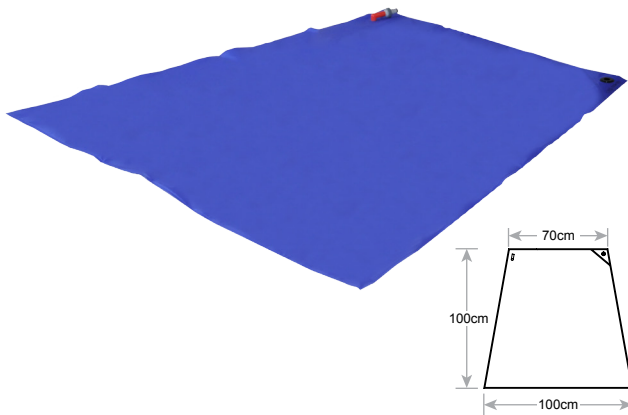

RT-4517-100100TRAP35 VacQfix Cushion, 100 cm x 100 cm, Nylon, Trapezoid, 35-liter fill

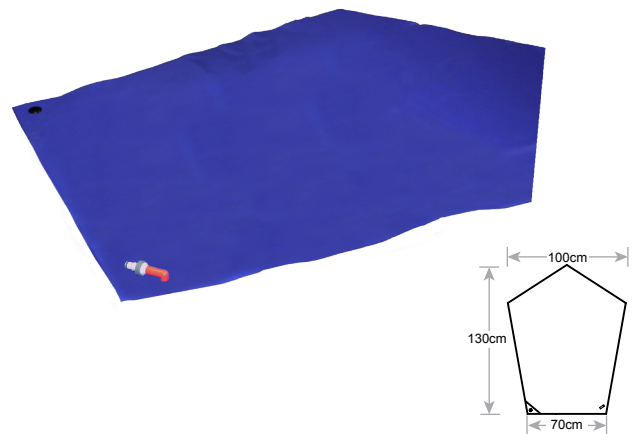

RT-4517-100130PENF45 VacQfix Cushion, 100 cm x 130 cm, Nylon, Pentagon, 45-liter fill

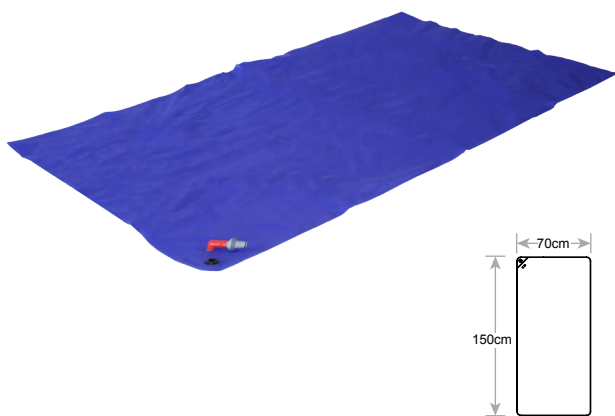

RT-4517-70150F60 VacQfix Cushion, 70 cm x 150 cm, Nylon, 60-liter fill, for hip or pelvis

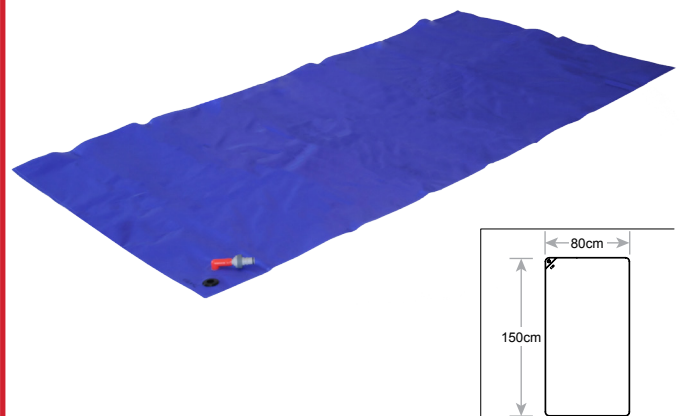

RT-4517-80150F65 VacQfix Cushion, 80 cm x 150 cm, Nylon, 65-liter fill, for hip or pelvis

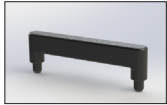

RT-4544KV-IND
Prone VacQfix Indexer

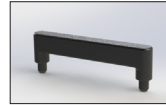
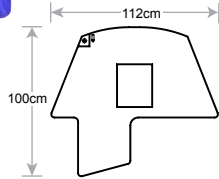

RT-4544KV-IND
Prone VacQfix Indexer

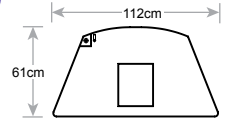

RT-4517-PB1 Access™ Prone VacQfix Cushion with contralateral breast support

RT-4517-PB2 Access™ Prone VacQfix Cushion without contralateral breast support

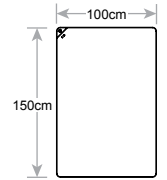

RT-4517-100150F70 VacQfix Cushion, 100 cm x 150 cm, Nylon, 70-liter, for pelvis or full body

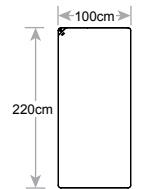
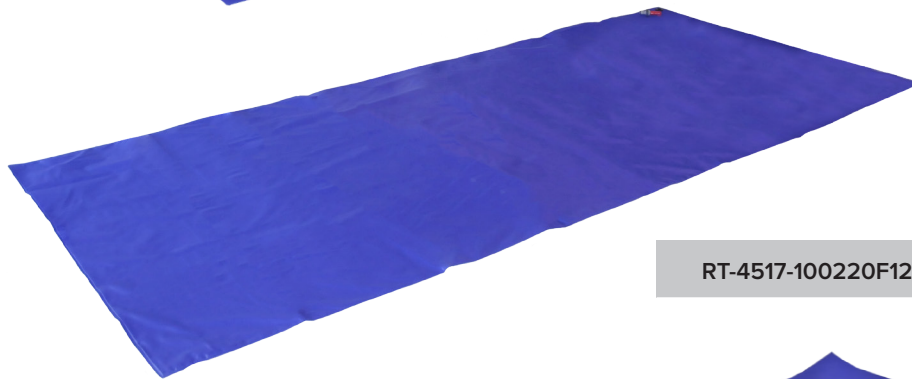

RT-4517-100220F120 VacQfix Cushion, 100 cm x 220 cm, Nylon, 120-liter fill, for full body

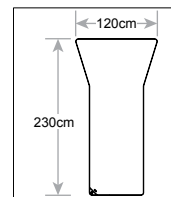

RT-4517-230120T80F90 VacQfix Cushion, Whole Body SBRT, 120 cm tapered to 80 cm x 230 cm, Nylon, with SingleStep

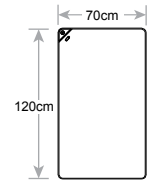

RT-4517-70120F40

VacQfix Cushion, 120 cm x 70 cm, 40-liter fill, Gen II, SS Valve

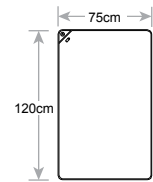
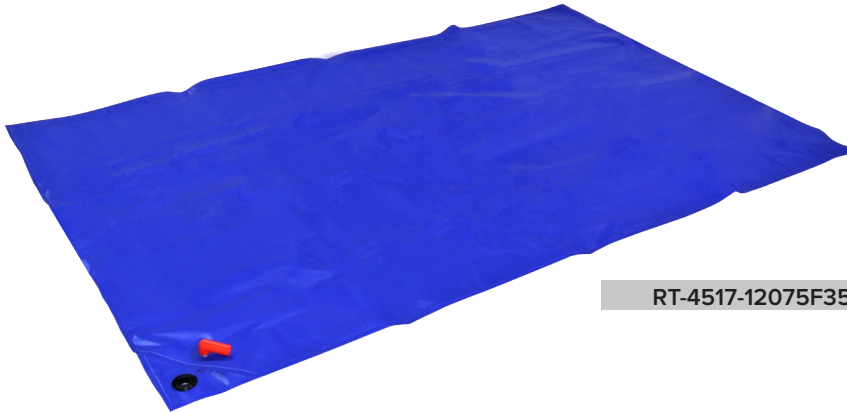

RT-4517-12075F35

VacQfix Cushion, 120 cm x 75 cm, 35-liter fill

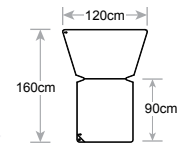
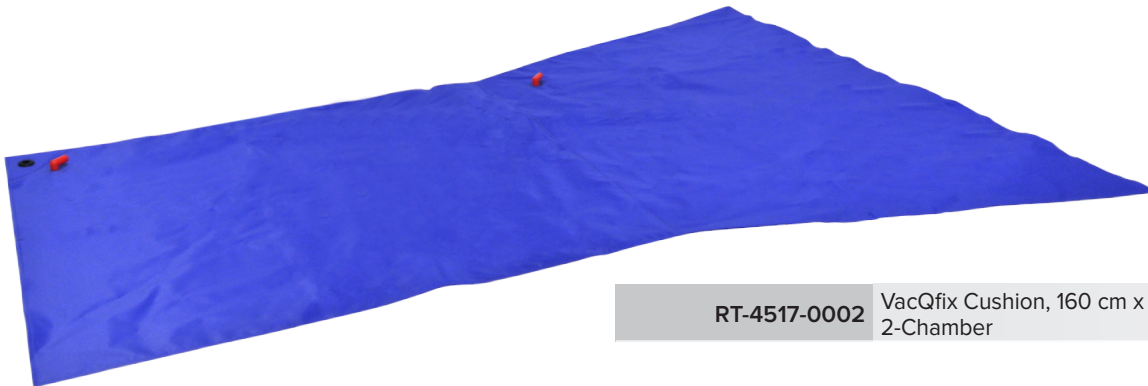

RT-4517-0002

VacQfix Cushion, 160 cm x 120 cm/80 cm, 2-Chamber

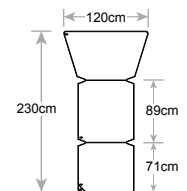
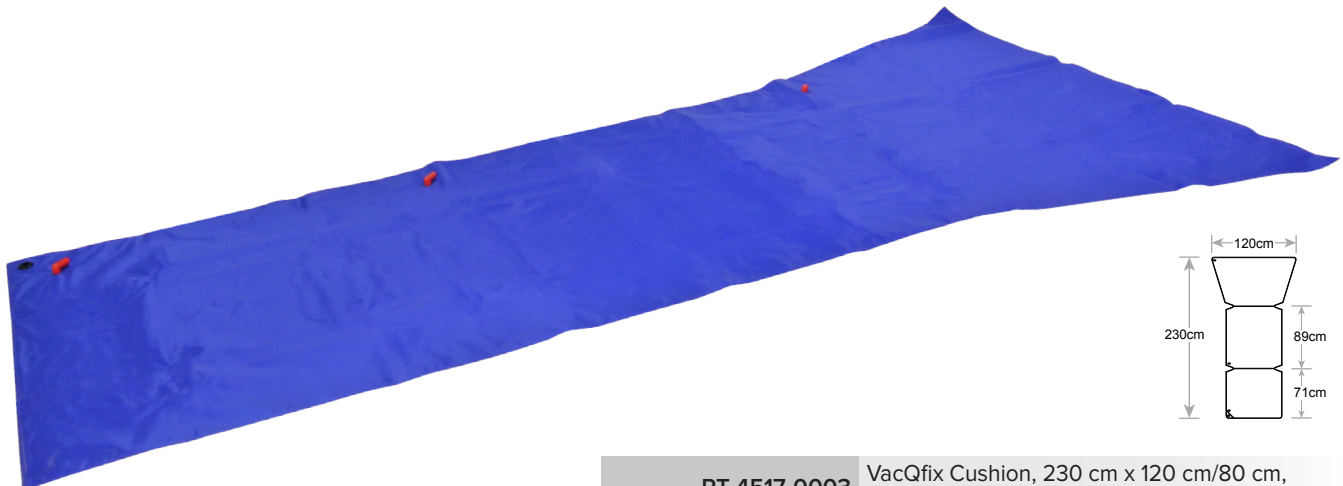

RT-4517-0003

VacQfix Cushion, 230 cm x 120 cm/80 cm, 3-Chamber

Available VacQfix Cushions

VacQfix™ Cushions can be used in tandem with the ArmShuttle™ Elite.



RT-4546C
ArmShuttle™ Elite

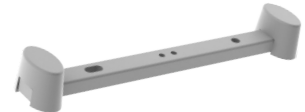

RT-4517-IND01
VacQfix™ Indexer

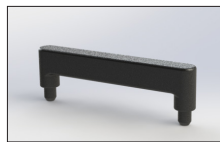

RT-4544KV-IND
Prone VacQfix™
Indexer



RT-4551BAR-01
Sliding Locating Bar



RT-4551BAR
Locating Bar

RT-4517-2535F2.0	VacQfix Cushion, 25 cm x 35 cm, Nylon, 2.0-liter fill
RT-4517-4080F15	VacQfix Cushion, 40 cm x 80 cm, Nylon, 15-liter fill, for extremities
RT-4517-5070F15	VacQfix Cushion, 50 cm x 70 cm, Nylon, 15-liter fill, for extremities
RT-4517-7070F20	VacQfix Cushion, 70 cm x 70 cm, Nylon, 20-liter fill, for upper body
RT-4517-T6565F7	VacQfix Cushion, 65 cm x 65 cm, T-Shaped, Nylon, 7-liter fill, for head & shoulders
RT-4517-T7993F20	VacQfix Breast Board Cushion, 79 cm x 93 cm, Nylon, 20-liter fill, with SingleStep Valve
RT-4517-10070F30*	VacQfix Cushion, 100 cm x 70 cm, Nylon, 30-liter fill
RT-4517-10070F35	VacQfix Cushion, 100 cm x 70 cm, Nylon, 35-liter fill
RT-4517-10070F40*	VacQfix Cushion, 100 cm x 70 cm, Nylon, 40-liter fill
RT-4517-100100F30*	VacQfix Cushion, 100 cm x 100 cm, Nylon, 30-liter fill
RT-4517-100100F40	VacQfix Cushion, 100 cm x 100 cm, Nylon, 40-liter fill, for upper body
RT-4517-100100TRAPF35	VacQfix Cushion, 100 cm x 100 cm, Nylon Trapezium (Trapezoid), 35-liter fill
RT-4517-100130PENF45	VacQfix Cushion, 100 cm x 130 cm, Nylon Pentagon, 45-liter fill
RT-4517-70150F60	VacQfix Cushion, 70 cm x 150 cm, Nylon, 60-liter fill, for hip or pelvis
RT-4517-80150F65	VacQfix Cushion, 80 cm x 150 cm, Nylon, 65-liter fill, for hip or pelvis
RT-4517-PB1	Access Prone VacQfix Cushion with contralateral breast support
RT-4517-PB2	Access Prone VacQfix Cushion without contralateral breast support
RT-4517-100150F70	VacQfix Cushion, 100 cm x 150 cm, Nylon, 70-liter fill, for pelvis or full body
RT-4517-100220F120	VacQfix Cushion, 100 cm x 220 cm, Nylon, 120-liter fill, for full body
RT-4517-230120T80F90	VacQfix Cushion, Whole Body SBRT, 120 cm tapered to 80 cm x 230 cm, Nylon, with SingleStep Valve
RT-4517-4079VF15*	VacQfix Cushion, Thigh Compression SBRT, 40 cm x 80 cm, Nylon, 15 liter fill with SingleStep Valve & Bridge Clips
RT-4517-70120F40	VacQfix Cushion, 120 cm x 70 cm, 40-liter fill, Gen II, SS Valve
RT-4517-12075F35	VacQfix Cushion, 120 cm x 75 cm, 35-liter fill
RT-4517-0002	VacQfix Cushion, 160 cm x 120 cm/80 cm, 2-Chamber
RT-4517-0003	VacQfix Cushion, 230 cm x 120 cm/80 cm, 3-Chamber

*Cushions not pictured. Lead times for VacQfix Cushions may vary, please call for availability.

All above cushions come with SingleStep Valve standard. To order the Economy Valve, add "M" to the end of the corresponding product code.



Qfix
Avondale, PA
+1 610.268.0585
sales@Qfix.com
www.Qfix.com